**KLT-MFA50-AR0234 V1.0****2.3MP OnSemi AR0234 Global Shutter MIPI Interface  
Fixed Focus Camera Module**

Front View

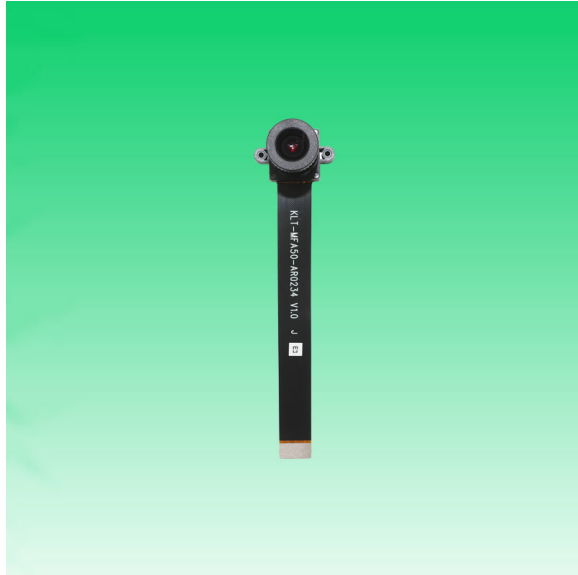

Back View

**Specifications**

<b>Camera Module No.</b>	<b>KLT-MFA50-AR0234 V1.0</b>
<b>Resolution</b>	2.3MP
<b>Image Sensor</b>	AR0234 Global Shutter
<b>Sensor Type</b>	1/2.6"
<b>Pixel Size</b>	3.0 um x 3.0 um
<b>EFL</b>	6.03 mm
<b>F.NO</b>	2.10
<b>Pixel</b>	1920 x 1200
<b>View Angle</b>	68.0°(DFOV) 57.0°(HFOV) 35.0°(VFOV)
<b>Lens Dimensions</b>	14.60 x 14.60 x 23.50 mm
<b>Module Size</b>	100.00 x 22.00 mm
<b>Module Type</b>	Fixed Focus
<b>Interface</b>	MIPI
<b>Auto Focus VCM Driver IC</b>	None
<b>Lens Type</b>	650nm IR Cut
<b>Operating Temperature</b>	-30°C to +70°C
<b>Mating Connector</b>	DF30FC-30DS-0.4V



## KLT-MFA50-AR0234 V1.0 2.3MP OnSemi AR0234 Global Shutter MIPI Interface Fixed Focus Camera Module

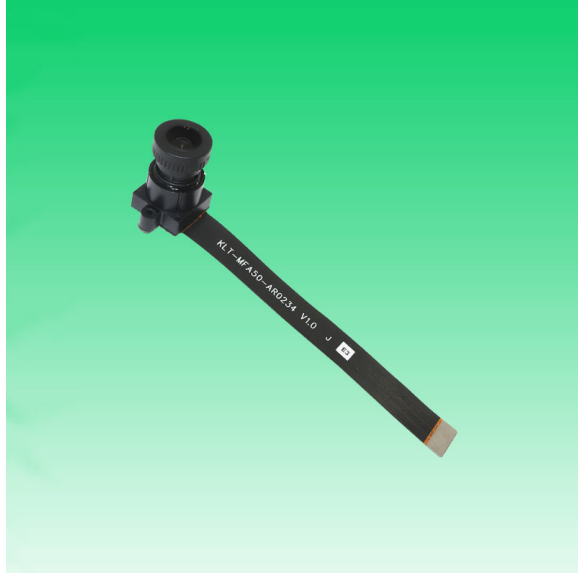

Top View

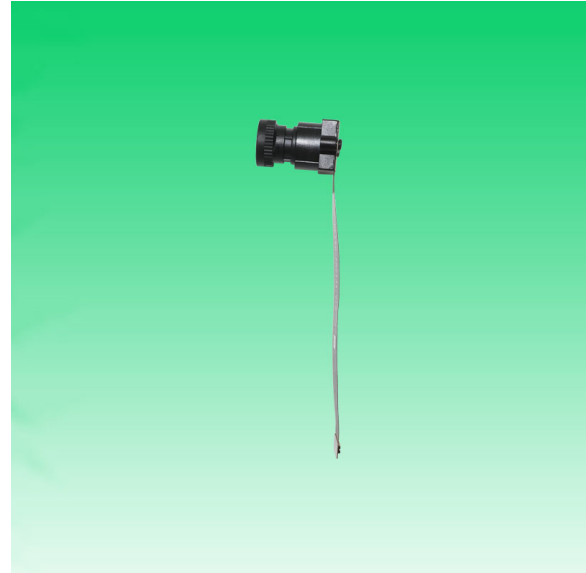

Side View



Bottom View



Mating Connector

RoHS	
PIN	SIGNAL
1	XSHUTDOWN
2	EXTCLK
3	RESET_BAR
4	SDATA
5	SCLK
6	NC
7	DOVDD 1.8V
8	DVDD 1.2V
9	AVDD 2.8V
10	AGND
11	CLK_P
12	CLK_N
13	DGND
14	DATA0_P
15	DATA0_N
16	DGND
17	DATA1_P
18	DATA1_N
19	DGND
20	DATA2_P
21	DATA2_N
22	DGND
23	DATA3_P
24	DATA3_N
25	DGND
26	TRIGGER
27	FLASH
28	NC
29	NC
30	NC

Version	Information
V1.0	First Version

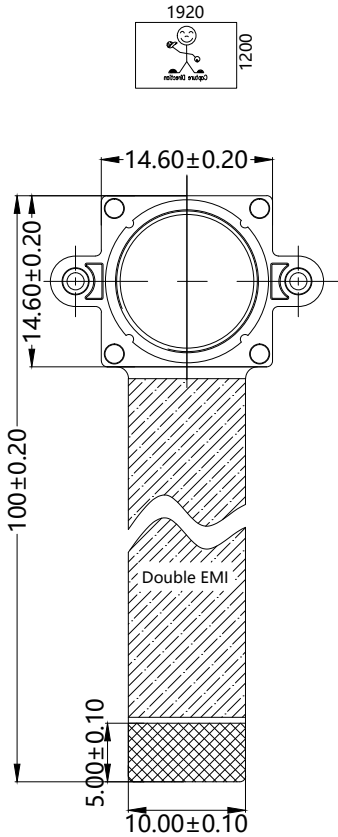

TOP VIEW

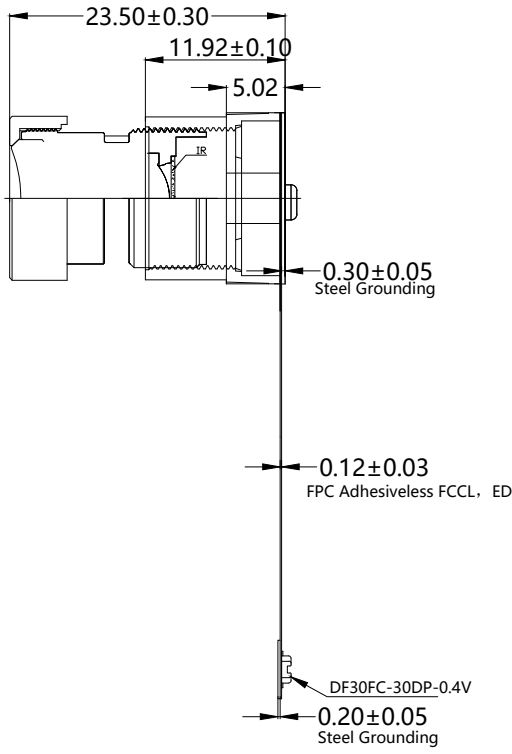

SIDE VIEW

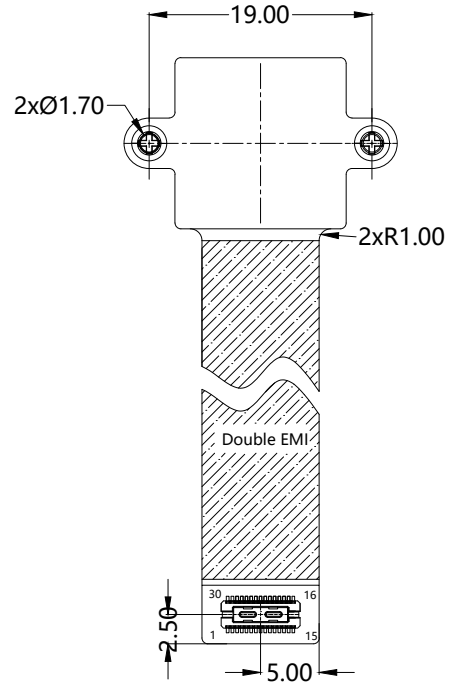

BOTTOM VIEW

NOTE:  
1.The device slave address:0x20(write);0x21(r);

Parameter:	
<b>1、Sensor specification:</b> Image Sensor: AR0234CSSC00SUKA0-CP Pixel: 3.0um*3.0um Lens Type: 1/2.6 Important Voltage Description: DVDD1.2V (external power supply);	<b>2、Lens specification:</b> FOV: 68°(D);57°(H);35°(V) F/NO.: 2.1 TV distortion: <-5% Focal length: 6.03mm Composition: 2G2P+IR FILTER IR Cut Coating: 650nm±10nm@50%

# Kai Lap Technologies Group Ltd

Designed By	Kevin	Model Name:	KLT-MFA50-AR0234 V1.0		
Checked By	Jacky	Projection Type:	Unit: mm	Date: 2/29/2024	
		 Third Angle	Scale: 1:1	Sheet: 1 of 1	Version: 1/0

## AR0234CS

# 1/2.6-inch 2.3 Mp CMOS Digital Image Sensor with Global Shutter

## Product Overview

For complete documentation, see the data sheet.

The AR0234CS is a 1/2.6-inch 2Mp CMOS digital image sensor with an active-pixel array of 1920 (H) x 1200 (V). It incorporates a new innovative global shutter pixel design optimized for accurate and fast capture of moving scenes at 120 frame per second, full resolution. The sensor produces clear, low noise images in both low-light and bright scenes. It includes sophisticated camera functions such as auto exposure control, windowing, row skip mode, column-skip mode, pixel-binning, and both video and single frame modes. It is programmable through a simple two-wire serial interface. The AR0234CS produces extraordinarily clear, sharp digital pictures with an industry leading Global Shutter Efficiency, and its ability to capture both continuous video and single frames makes it the perfect choice for a wide range of applications, including scanning, autonomous mobility, surveillance and industrial quality control.

### Features

- Best in Class Global Shutter Efficiency
- Low Dark Current/Hot Pixels
- High Linear Full Well
- Low Operational Power
- Small Form Factor
- Built-In Statistics Engine
- Multiple Functional Modes - Row & Col Skip Modes, Pixel Binning

### Applications

- Gesture recognition
- 3D scanning
- Position tracking
- Machine vision
- AR/VR/MR/XR

































### Benefits

- Superior Image Quality for fast-moving objects
- Reduced Total Noise Floor, Higher SNR delivering High Image Fidelity
- High Dynamic Range, delivers higher image clarity
- Suitable of Battery Powered Applications
- Ideal for Space Constrained Applications
- Offloads Image Processor Loads, provides scene details with Prog. ROI
- Application-specific Image Quality Selections with Performance/Power Trade-offs

### End Products

- Autonomous Mobile Robots
- Autonomous Guide Vehicles (Drones)
- Video Doorbells
- AR/VR/MR Headsets
- Barcode Readers

## Part Electrical Specifications

Product	Pricing (\$/Unit)	Compliance	Status	Type	Megapixels	Frame Rate (fps)	Optical Format	Shutter Type	Pixel Size (µm)	Output Interface	Color	Package Type
AR0234CSSC00 SUD20		 	NEW	CMOS	2.3	120	1/2.6 inch	Global Shutter	3.0 x 3.0		Color	
AR0234CSSC00 SUKA0-CP		 	Active	CMOS	2.3	120	1/2.6 inch	Global Shutter	3.0 x 3.0		Color	ODCSP-83
AR0234CSSC00 SUKA0-CP1		 	Active	CMOS	2.3	120	1/2.6 inch	Global Shutter	3.0 x 3.0		Color	ODCSP-83
AR0234CSSC00 SUKA0-CR		 	Active	CMOS	2.3	120	1/2.6 inch	Global Shutter	3.0 x 3.0		Color	ODCSP-83
AR0234CSSC28 SUD20		 	NEW	CMOS	2.3	120	1/2.6 inch	Global Shutter	3.0 x 3.0		Color	
AR0234CSSC28 SUKA0-CP		 	Active	CMOS	2.3	120	1/2.6 inch	Global Shutter	3.0 x 3.0		Color	ODCSP-83
AR0234CSSC28 SUKA0-CP1		 	Active	CMOS	2.3	120	1/2.6 inch	Global Shutter	3.0 x 3.0		Color	ODCSP-83
AR0234CSSC28 SUKA0-CR		 	Active	CMOS	2.3	120	1/2.6 inch	Global Shutter	3.0 x 3.0		Color	ODCSP-83
AR0234CSSM0 0SUD20		 	NEW	CMOS	2.3	120	1/2.6 inch	Global Shutter	3.0 x 3.0		Mono	
AR0234CSSM0 0SUKA0-CP		 	Active	CMOS	2.3	120	1/2.6 inch	Global Shutter	3.0 x 3.0		Mono	ODCSP-83
AR0234CSSM0 0SUKA0-CP1		 	Active	CMOS	2.3	120	1/2.6 inch	Global Shutter	3.0 x 3.0		Mono	ODCSP-83
AR0234CSSM0 0SUKA0-CR		 	Active	CMOS	2.3	120	1/2.6 inch	Global Shutter	3.0 x 3.0		Mono	ODCSP-83
AR0234CSSM2 8SUD20		 	NEW	CMOS	2.3	120	1/2.6 inch	Global Shutter	3.0 x 3.0		Mono	
AR0234CSSM2 8SUKA0-CP		 	Active	CMOS	2.3	120	1/2.6 inch	Global Shutter	3.0 x 3.0		Mono	ODCSP-83
AR0234CSSM2 8SUKA0-CP1		 	Active	CMOS	2.3	120	1/2.6 inch	Global Shutter	3.0 x 3.0		Mono	ODCSP-83
AR0234CSSM2 8SUKA0-CR		 	Active	CMOS	2.3	120	1/2.6 inch	Global Shutter	3.0 x 3.0		Mono	ODCSP-83

# 0.4 mm Pitch, 0.9 mm Height, Board-to-Board / Board-to-FPC Connectors

## DF30 Series



### Extremely small size

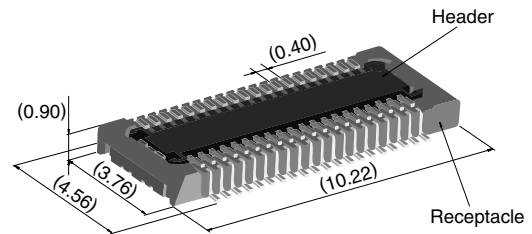

40 positions shown

### Overview

Continuous miniaturization and increased component density on PCB created demand for extremely low profile connectors. This series is addition of a new extremely low profile connectors to Hirose's wide range of high reliability board-to-board/board-to-FPC connection solutions.

### Features

#### 1. Contact reliability

Concentration of the contact's normal forces at the single point assures good contact wipe and electrical reliability, while confirming the fully mated condition with a definite tactile click.

#### 2. Self alignment

Recognizing the difficulties of mating extremely small connectors in limited spaces the connectors will self align in horizontal axis within 0.3 mm.

#### 3. Automatic board placement

Packaged on tape-and-reel the plug and headers have sufficiently large flat areas to allow pick-up with vacuum nozzles of automatic placement equipment.

#### 4. Variety of contact positions and styles

Available in standard contact positions of: 20, 22, 24, 30, 34, 40, 50, 60, 70 and 80 with and without metal fittings. Addition of metal fittings does not affect external dimensions of the connectors.

Smaller contact positions are also available.

#### 5. Support for continuity test connector

Connectors which have increased insertion and removal durability are available for continuity tests. Contact your Hirose sales representative for details.

### Applications

Cellular phones, PDA's, mobile computers, digital cameras, digital video cameras, and other devices demanding high reliability connections in extremely limited spaces.

#### Low profile

#### Increased mated retention

#### High contact reliability



### Self alignment



## Product Specifications

Rating	Rated current 0.3A	Operating temperature range : -35°C to 85°C (Note 1)	Storage temperature range -10°C to 60°C (Note 2)
	Rated voltage 30V AC	Operating humidity range : Relative humidity 20% to 80%	Storage humidity range Relative humidity 40% to 70% (Note 2)

Item	Specification	Conditions
1. Insulation resistance	50 MΩ min.	100V DC
2. Withstanding voltage	No flashover or insulation breakdown.	100V AC / one minute
3. Contact resistance	100 mΩ max.	100 mA
4. Vibration	No electrical discontinuity of 1 μs or more	Frequency: 10 to 55 Hz, single amplitude of 0.75mm, 2 hours, 3 axis
5. Humidity	Contact resistance: 100 mΩ max. Insulation resistance: 25 MΩ min.	96 hours at temperature of 40°C±2°C and RH of 90% to 95%
6. Temperature cycle	Contact resistance: 100 mΩ max. Insulation resistance: 50 MΩ min.	Temperature: -55°C→+5°C to +35°C→+85°C→+5°C to +35°C Duration: 30→10→30→10(Minutes) 5 cycles
7. Durability (insertions/withdrawals)	Contact resistance: 100 mΩ max.	50 cycles(Connector for conductivity tests: 500 cycles)
8. Resistance to soldering heat	No deformation of components affecting performance.	Reflow: At the recommended temperature profile Manual soldering: 300°C for 3 seconds

Note 1: Includes temperature rise caused by current flow.

Note 2: The term "storage" refers to products stored for long period of time prior to mounting and use. Operating temperature range and humidity range covers non-conducting condition of installed connectors in storage, shipment or during transportation.

## Materials and Finishes

Connectors	Component	Material	Finish	Remarks
Receptacles and Headers	Insulator	LCP	Color : Black	UL94V-0
	Contacts	Phosphor bronze	Gold plated	————
	Metal fittings	Phosphor bronze	Tin-copper plated	————

## Ordering information

### Receptacles and Headers

**DF30**   **FC** -   **\***   **DS - 0.4**   **V**   **(\*\*)**  
①   ②   ③   ④   ⑤   ⑥   ⑦

① Series name: DF30	⑤ Contact pitch: 0.4 mm
② Configuration FB: With metal fittings, without bosses FC: Without metal fittings, without bosses CJ: Connector for conductivity tests	⑥ Termination section V: Straight SMT
③ Number of positions: 20, 22, 24, 30, 34, 40, 50, 60, 70, 80	⑦ Packaging (81): Embossed tape packaging (5,000 pieces per reel) (82): Embossed tape packaging (1,000 pieces per reel)
④ Connector type DS: Double row receptacle DP: Double row header	

## ■ Receptacles (without metal fittings)

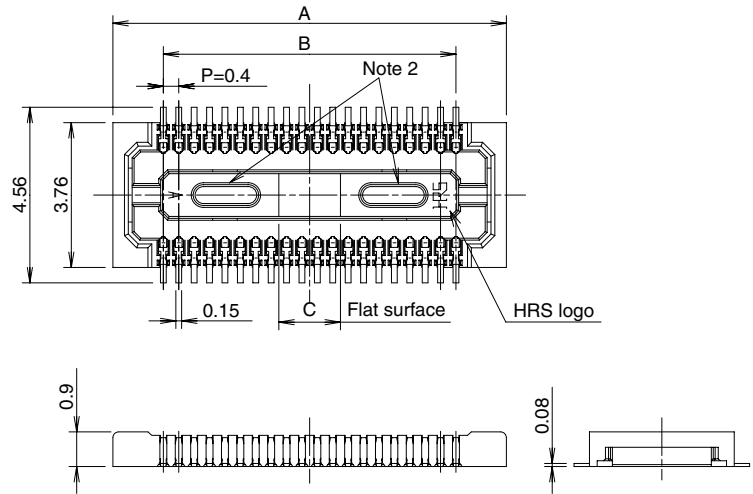

## ◆ Recommended PCB mounting pattern



Recommended solder paste thickness: 120  $\mu\text{m}$

[Specification number] -\*\*, (\*\*)

(81): Embossed tape packaging (5,000 pieces per reel)

\* Tolerances non- accumulative.

Unit: mm

Part Number	CL No.	Number of contacts	A	B	C
DF30FC-20DS-0.4V(**)	CL684-1109-8-**	20	6.22	3.6	1.2
DF30FC-22DS-0.4V(**)	CL684-1110-7-**	22	6.62	4.0	1.2
DF30FC-24DS-0.4V(**)	CL684-1111-0-**	24	7.02	4.4	1.2
DF30FC-30DS-0.4V(**)	CL684-1112-2-**	30	8.22	5.6	1.2
DF30FC-34DS-0.4V(**)	CL684-1113-5-**	34	9.02	6.4	1.36
DF30FC-40DS-0.4V(**)	CL684-1078-6-**	40	10.22	7.6	1.6
DF30FC-50DS-0.4V(**)	CL684-1114-8-**	50	12.22	9.6	2.0
DF30FC-60DS-0.4V(**)	CL684-1082-3-**	60	14.22	11.6	2.4
DF30FC-70DS-0.4V(**)	CL684-1115-0-**	70	16.22	13.6	2.8
DF30FC-80DS-0.4V(**)	CL684-1116-3-**	80	18.22	15.6	3.2

Note 1: Order by number of reels.

Note 2: Receptacles with 24 or fewer contacts positions will not have recessed areas.





## Cameras Applications



Automotive Driver Pilot



Live Streaming



Video Conference



Eye Tracker Biometric Detection



Machine Vision



Agricultural Monitor



Night Vision Security



Drone and Sports Eagle Eyes



Interactive Pet Camera





*your BEST camera module partner*

## Cameras Applications

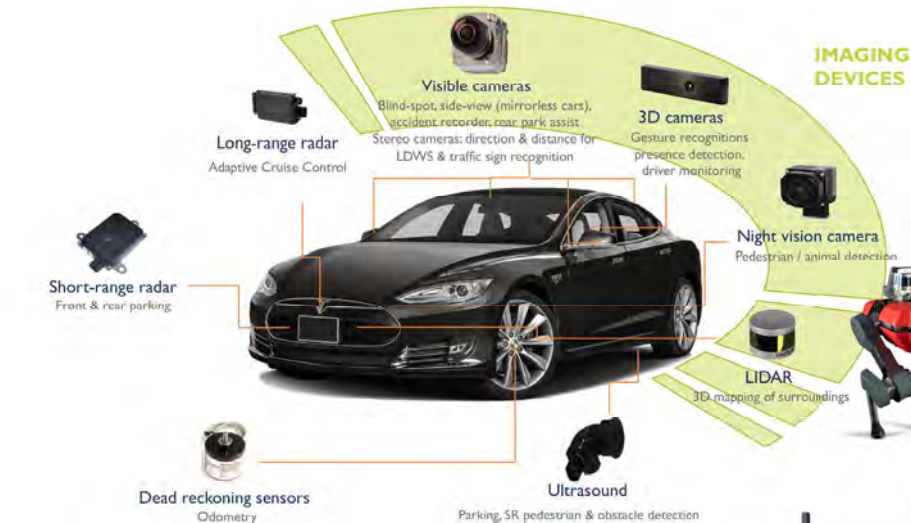

## IMAGING DEVICES





## Camera Module Pinout Definition Reference Chart

OmniVision	Sony	Samsung	On-Semi	Aptina	Himax	GalaxyCore	PixArt	SmartSens	Sensors
Pin Signal									
Description									
DGND	GND								
AGND									
PCLK	DCK								
XCLR	PWDN	XSHUTDOWN	STANDBY						
MCLK	XVCLK	XCLK	INCK						
RESET	RST								
NC	NULL								
SDA	SIO_D	SIOD							
SCL	SIO_C	SIOC							
VSYNC	XVS	FSYNC							
HREF	XHS								
DOVDD									
AFVDD									
AVDD									
DVDD									
STROBE	FSTROBE								
FSIN									
SID									
ILPWM									
FREX									
GPIO									
SLASEL									
AFEN									
<b>MIPI Interface</b>									
MDN0	DN0	MD0N	DATA_N	DMO1N					
MDP0	DP0	MD0P	DATA_P	DMO1P					
MDN1	DN1	MD1N	DATA2_N	DMO2N					
MDP1	DP1	MD1P	DATA2_P	DMO2P					
MDN2	DN2	MD2N	DATA3_N	DMO3N					
MDP2	DP2	MD2P	DATA3_P	DMO3P					
MDN3	DN3	MD3N	DATA4_N	DMO4N					
MDP3	DP3	MD3P	DATA4_P	DMO4P					
MCN	CLKN	CLK_N	DCKN						
MCP	CLKP	MCP	CLK_P	DCKN					
<b>DVP Parallel Interface</b>									
D0	DO0	Y0							
D1	DO1	Y1							
D2	DO2	Y2							
D3	DO3	Y3							
D4	DO4	Y4							
D5	DO5	Y5							
D6	DO6	Y6							
D7	DO7	Y7							
D8	DO8	Y8							
D9	DO9	Y9							
D10	DO10	Y10							
D11	DO11	Y11							



## Camera Reliability Test

Reliability Inspection Item		Testing Method	Acceptance Criteria	
Category	Item			
Environmental	Storage Temperature	High 60°C 96 Hours	Temperature Chamber	No Abnormal Situation
		Low -20°C 96 Hours	Temperature Chamber	No Abnormal Situation
	Operation Temperature	High 60°C 24 Hours	Temperature Chamber	No Abnormal Situation
		Low -20°C 24 Hours	Temperature Chamber	No Abnormal Situation
	Humidity	60°C 80% 24 Hours	Temperature Chamber	No Abnormal Situation
	Thermal Shock	High 60°C 0.5 Hours Low -20°C 0.5 Hours Cycling in 24 Hours	Temperature Chamber	No Abnormal Situation
Physical	Drop Test (Free Falling)	Without Package 60cm	10 Times on Wood Floor	Electrically Functional
		With Package 60cm	10 Times on Wood Floor	Electrically Functional
	Vibration Test	50Hz X-Axis 2mm 30min	Vibration Table	Electrically Functional
		50Hz Y-Axis 2mm 30min	Vibration Table	Electrically Functional
		50Hz Z-Axis 2mm 30min	Vibration Table	Electrically Functional
	Cable Tensile Strength Test	Loading Weight 4 kg 60 Seconds Cycling in 24 Hours	Tensile Testing Machine	Electrically Functional
Electrical	ESD Test	Contact Discharge 2 KV	ESD Testing Machine	Electrically Functional
		Air Discharge 4 KV	ESD Testing Machine	Electrically Functional
	Aging Test	On/Off 30 Seconds Cycling in 24 Hours	Power Switch	Electrically Functional
	USB Connector	On/Off 250 Times	Plug and Unplug	Electrically Functional







Inspection Item		Inspection Method	Standard of Inspection		
Category	Item				
Appearance	FPC/ PCB	Color	The Naked Eye	Major Difference is Not Allowed.	
		Be Torn/Chopped	The Naked Eye	Copper Crack Exposure is Not Allowed.	
		Marking	The Naked Eye	Clear, Recognizable (Within 30cm Distance)	
	Holder	Scratches	The Naked Eye	The Inside Crack Exposure is Not Allowed	
		Gap	The Naked Eye	Meet the Height Standard	
		Screw	The Naked Eye	Make Sure Screws Are Presented (If Any)	
		Damage	The Naked Eye	The Inside Crack Exposure is Not Allowed	
	Lens	Scratch	The Naked Eye	No Effect On Resolution Standard	
		Contamination	The Naked Eye	No Effect On Resolution Standard	
		Oil Film	The Naked Eye	No Effect On Resolution Standard	
		Cover Tape	The Naked Eye	No Issue On Appearance.	
	Function	Image	No Communication	Test Board	Not Allowed
			Bright Pixel	Black Board	Not Allowed In the Image Center
Dark Pixel			White board	Not Allowed In the Image Center	
Blurry			The Naked Eye	Not Allowed	
No Image			The Naked Eye	Not Allowed	
Vertical Line			The Naked Eye	Not Allowed	
Horizontal Line			The Naked Eye	Not Allowed	
Light Leakage			The Naked Eye	Not Allowed	
Blinking Image			The Naked Eye	Not Allowed	
Bruise			Inspection Jig	Not Allowed	
Resolution			Chart	Follows Outgoing Inspection Chart Standard	
Color			The Naked Eye	No Issue	
Noise			The Naked Eye	Not Allowed	
Corner Dark			The Naked Eye	Less Than 100px By 100px	
Color Resolution			The Naked Eye	No Issue	
Dimension	Height	The Naked Eye	Follows Approval Data Sheet		
	Width	The Naked Eye	Follows Approval Data Sheet		
	Length	The Naked Eye	Follows Approval Data Sheet		
	Overall	The Naked Eye	Follows Approval Data Sheet		



## KLT Package Solutions

KLT Camera Module



Complete with Lens Protection Film



Tray with Grid and Space



Place Cameras on the Tray





## Camera Modules Package Solution

Full Tray of Cameras



Cover Tray with Lid



Put Tray into Anti-Static Bag



Vacuum the Anti-Static Bag

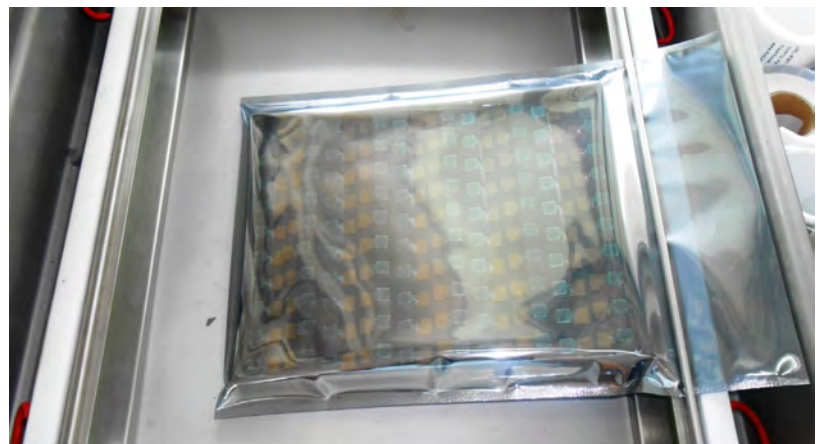





## Camera Modules Package Solution

Sealed Vacuum Bag with Labels

1. Model and Description 2. Quantity 3. Shipping Date 4. Caution







## Large Order Package Solution

Place Foam Sheets Between Trays



Foam Sheets are Slightly Larger than Trays



Place Foam Sheets and Trays into Box



Foam Sheets are Tightly Fitting Box





## Small Order Package Solution

Place Foam Sheets and Trays into Small Box



Foam Sheets are Nicely Fitting the Small Box



Package in Small Box for Shipment



Place Small Boxes into Larger Box







*your BEST camera module partner*

## Carbon Box Package Solution

Seal the Carbon Box

Final Package Labelled Box



### Carbon Box Ready for Shipment

1. Delivery Address and Phone No. 2. Box No. and Ship Date 3. Fragile Caution





## Sample Order Package Solution

Place Sample into Small Anti-Static Bag



Place Connectors into Small Ant-Static Bag



### Sample Labels on the Small Bag

1. Camera Module or Connector Model
2. Shipping Date and Quantity
3. Caution







## Connectors Large Order Package Solution

Connectors in a Wheel



Label Connectors in the Wheel



The Wheel is Perfectly Fitting the Box



Connectors Box Ready for Shipment



**Company Kai Lap Technologies (KLT)**

Kai Lap Technologies Group Limited. (KLT) was established in 2009, a next-generation technology driven manufacturer specialized in research, design, and produce of audio and video products. KLT is occupying 20,000 square feet automated plants with 100 employees of annual throughput 30,000,000 units cameras.

KLT provides OEM, ODM design, contract manufacturing, and builds the camera products. You may provide the requirements to us, even with a hand draft, our sales and engineering work together to meet your needs. We consider ourselves your last-term partner in developing practical and innovative solutions.

Our team covers everything from initial concept development to mass produced product. KLT specializes in customized camera design, raw material, electronic engineering, firmware/software development, product testing, and packing design. Our experienced strategic supply systems offer a robust and dependable manufacturing capacity for orders of various sizes.

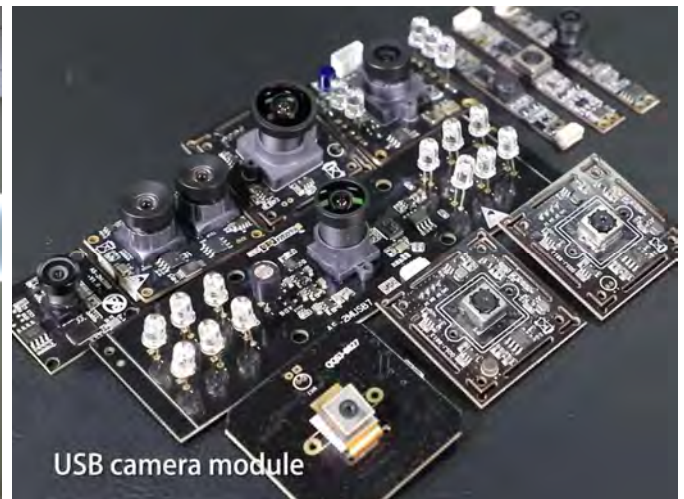
**Limited Warranty**

KLT provides the following limited warranty if you purchased the Product(s) directly from KLT company or from KLT's website, [www.KaiLapTech.com](http://www.KaiLapTech.com). Product(s) purchased from other sellers or sources are not covered by this Limited Warranty. KLT guarantees that the Product(s) will be free from defects in materials and workmanship under normal use for a period of one (1) year from the date you receive the product ("Warranty Period").

For all Product(s) that contain or develop material defects in materials or workmanship during the Warranty Period, KLT will, at its sole option, either: (i) repair the Product(s); (ii) replace the Product(s) with a new or refurbished Product(s) (replacement Product(s) being of identical model or functional equivalent); or (iii) provide you a refund of the price you paid for the Product(s).

This Limited Warranty of KLT is solely limited to repair and/or replacement on the terms set forth above. KLT is not reliable or responsible for any subsequent events.







# CMOS CAMERA MODULES



*your BEST camera module partner*

## KLT Strength

### Powerful Factory



### Professional Service



### Promised Delivery



[www.KaiLapTech.com](http://www.KaiLapTech.com) [sales@KaiLapTech.com](mailto:sales@KaiLapTech.com) Tel: (852) 6908 1256 Fax: (852) 3017 6778

All rights reserved @ Kai Lap Technologies Group Ltd. Specifications subject to change without notice.